





















Charmglow MODEL HEJ-1 GAS BARBEQUE

PARTS

1		440030	Comfort Touch Handle Kit	\$ --
2		440034	Screw (#10-24 x 2 1/2"), 2-Req'd.	\$
3		440033	Comfort Touch Handle	\$
4		440031	Spacer, 2-Req'd.	\$
5		440032	Insulating Washer, 2-Req'd.	\$
6		440036	Nut (#10-24), 2-Req'd.	\$
7		344020	Cast Aluminum Top	\$
8		444050	All Purpose Rack (Chrome)	\$
9		444060	Stainless Steel Cooking Grid, 2-Req'd.	\$
10		440160	Charm-Rok, 1-Bag (64 Pieces)	\$
11		444070	Heavy Duty Grate	\$
12		244060	H-Burner Assembly	\$
13		444061	H-Burner	\$
14		440082	Gasket	\$
15		440083	Venturi Tube	\$
16		440088	Screw (1/4-20 x 3/4" Hex. Hd.), 2-Req'd.	\$
17		440084	Venturi Air Mixer	\$
18		440087	Screw (10-24 x 1/4 Truss Hd.)	\$
19		344040	Rotating Cast Aluminum Pit	\$
20		440243	Locking Thumb Screw (1/4-20 x 1" with nut)	\$
21		440181	Grease Cup Holder	\$

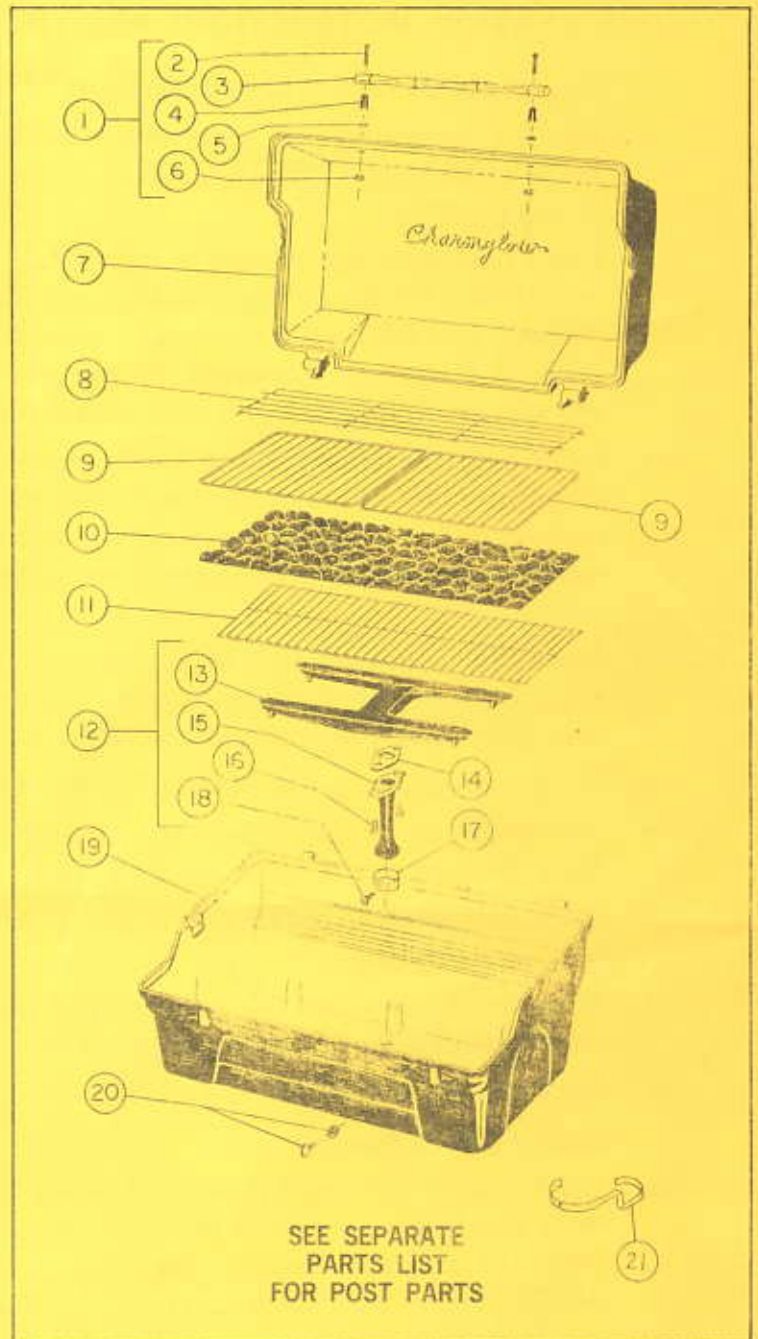

RETAIL PRICES ARE SUGGESTED ONLY
AND MAY VARY IN DIFFERENT TRADING AREAS
MINIMUM ORDER \$10.00

PHONE: 312-395-4221

CHARMGLOW PRODUCTS

ANTIOCH, ILLINOIS 60002

2972



WHEN YOU BUY CHARMGLOW . . .

YOU BUY THE FINEST

INSTALLATION INSTRUCTIONS FOR THE HEJ-1 GAS-FIRED OUTDOOR BARBEQUE

1. Dig a hole 24 inches deep and about 12 inches in diameter.
2. Remove mounting post assembly (154150) from carton. From the top of the post, remove valve knob (440110) and place on brass valve stem. Turn valve knob so "off" is in top position.
3. Place post in center of hole and attach gas supply line to gas line in post. Control valve knob (440110) should face in direction where it is most easily accessible. Plumb post roughly and fill hole with cement to within one inch below gas line, using care not to cover gas line with concrete. Plumb post true and allow cement to set before continuing with installation. Refill hole with dirt to grade level.
4. Place cast aluminum pit (344040) on post as far as it will go and lock wing nut. Make sure that front of barbeque faces in same direction as valve knob (440110). For positioning in any direction to avoid the wind, loosen wing nut and rotate slowly to desired position and lock again. Rotate occasionally to prevent pit (344040) from freezing to post.
5. Place "H" burner (244080) in cast aluminum pit, inserting air-mixer in hole in center of pit bottom and slowly lower until the center hole in the air mixer fits over the orifice cap. The burner legs should be relatively level on the bottom of the pit.
6. Place heavy duty grate (444070) into cast aluminum pit as far down as it will go.
7. Distribute the Charm-Rok (440160) evenly over heavy duty grate. Note: Charm-Rok does not turn red in color when heated.
8. Place cooking grids (444060) in place. All purpose rack (444050) is placed in position only when in use.
9. Place the 2 bolts into the handle, then put the handle spacers and washers on the bolts. Insert the assembly into the holes in the cast aluminum top and tighten nuts.
10. Place cast aluminum top (344020) on top of the cast aluminum pit. Raise top by handle.
11. Supply gas to gas line.
12. Light match with right hand and insert lighted match in igniter hole located on the right side lower portion of the cast aluminum pit, with left hand press valve handle (440110) and turn counterclockwise to high position.
IMPORTANT: NEVER LIGHT GAS BARBEQUE WITH COVER CLOSED!
13. The first time the barbeque is lighted, it should be allowed to burn in the low position for about one hour to burn off the newness.

NOTE: For maintenance and cooking instructions, please refer to cookbook in your barbeque.

When using the 24" post the cast aluminum base (150870) must be bolted to platform or concrete slab.

The burner is made of CHARMALLOY, a special alloy that oxidizes and prevents future corrosion. It actually tones a "rust" color to seal the metal from the elements giving the burner longer years of service than any other on the market.

USING YOUR GAS-FIRED BARBEQUE

1. Be sure the Charm-Rok are distributed evenly, one layer thick, over the entire surface of your grate. Under normal use, and by occasionally turning the layer upside down to burn off excessive grease, the Charm-Rok should last for years and years.
2. If you have a model JAK, TNK, AMK, HEJ and SNR on 24" and 48" posts, swivel your barbeque with its "back" to the wind before you light the barbeque on especially windy days. Loosen the thumbscrew just below the pit, turn the barbeque as desired, then tighten up on the thumbscrew.
3. Always light your gas-fired barbeque with the lid wide open. Turn the heat control to "high" and hold a lighted match in the ignition hole at the lower right hand corner of the pit. Keep the lid up and leave the control on "high" for about 10 minutes to heat the Charm-Rok thoroughly before you begin cooking. The Charm-Rok will not turn color when heated, so allow ample warm-up time.
4. For broiling and most grilling, you will want to leave the lid open. But for roasting with or without a rotisserie, the lid could be closed. With the lid closed, "low" heat will hold the temperature at about 300 degrees. "High" will hold the temperature about 500 degrees. Outside air temperatures will affect cooking temperatures so a meat thermometer is recommended for roasts.
5. Some "flare up" of meat juices dripping onto the heated Charm-Rok contributes to the outdoor flavor you expect from your gas barbeque, but excessive flaming can burn meat. "Flare-up" is minimized with a gas barbeque because you can control the heat. If you trim excess fat from meat before grilling, most drippings will be dissipated by the radiant heat of the Charm-Rok. If flame persists, just sprinkle a little water on the Charm-Rok and the flames will be extinguished.
6. **NOTE: We recommend that foods being cooked not be left unattended for long periods of time since "flare-up" can burn foods.**

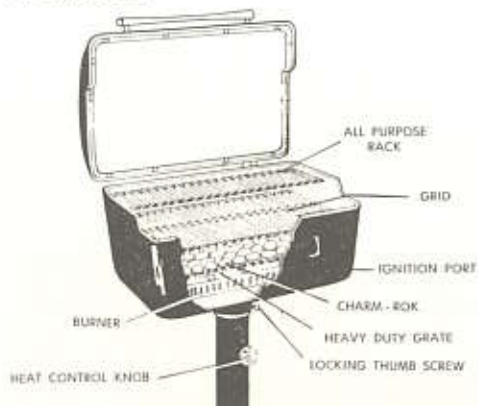

Granted Design Patent #206,976 By U. S. Patent Office.

One Year Warranty

on

Charmglow's Outdoor Gas Fired Lamps & BBQ's

"We warrant to the original purchaser this appliance, when subjected to normal use and service, to be free from defects, in material and workmanship for a period of one year from the date of original purchase.

Repair or replacement will be made at the factory on any part returned, PREPAID, through the dealer, with a sales slip showing date of purchase, and claimed within the warranty period to be defective.

Replacement shall be F.O.B. factory and the Company shall not be liable for transportation charges, labor costs, and/or export duties.

This warranty shall not apply, nor can we assume any responsibility for consequential damages that might result from its mis-use or improper installation, where the product has been tampered with or altered in any way, or which in our judgment, has been subjected to mis-use, negligence or accident.

This warranty is in lieu of all other warranties expressed or implied and all other obligation or liabilities on our part, and we do not authorize any person or representative to assume for us any other obligation or liability in connection with the sale of this product.

Charmglow's Burner Guarantee

The Charmalloy burner in this appliance is fully guaranteed against rust-out and/or burn-out, under normal domestic use not exceeding standard pressures and/or fuel rating, for a period of one year from date of original purchase.

No charge repair or replacement will be made at the factory on the Charmalloy burner returned, PREPAID, through the dealer, with a sales slip showing date of purchase, and claimed within the warranty period to be defective and found by the Company upon examination to be so defective.

No guarantee on gas mantles."

Charmglow PRODUCTS
312 - 395-4221



Antioch, Illinois
60002

8048

How To Care For Your

Charmglow®

GAS LAMP and GRILL



How to Care for Your Charmglow Gas Lamp and Gas-Fired Barbeque

CLEANING YOUR LAMP

1. If your lamp is equipped with an upright burner and you have a glass chimney to clean, first shut off the gas lamp and allow the lamp to cool. To do this, follow these directions: On most gas lamps, the gas valve is located in the collar of lamp. A 3/4" hole in the collar permits access to the valve which has a slotted head that can be turned by a screwdriver. Turn off the gas by turning the slot to a horizontal position. If your gas lamp has an inverted burner, upright without glass chimney, or if the glass chimney does not need cleaning on the upright burner, you do not need to turn off the gas to clean the glass panels.
2. After the lamp has cooled, remove the glass panels for cleaning. Lift up on the glass panel to be removed, slip your finger under the bottom of the glass panel, and lower to remove. The mantle of your gas lamp is delicate, so avoid bumping it or exposing it to high winds when you clean the glass panels. If your gas lamp has a chimney, leave it in place when you clean the glass and lift it off only after three panels are back in position. Clean the chimney as you would a drinking glass and set it back in position without touching the mantle.
3. Relight your gas lamp by holding a lighted match close to but not touching the mantle as you turn the slotted head of the valve back to the vertical position. If your lamp has a chimney, hold the lighted match at the top of the chimney while you turn on the gas. After lighting, replace the glass panel, relock the set screw in your lamphead, (check to make sure it is tight) and your gas lamp is ready for use.



REPLACING MANTLES

1. Shut off the gas and allow the gas lamp to cool. (see item 1 above). Then remove one glass panel. (see item 2 above)
2. To replace an inverted mantle, grasp one of the ceramic "wings" of the old mantle and lift to disconnect the ceramic wings from the hanger ledges. Turn slightly and lower the old mantle away from the burner. Lift the new mantle by the ceramic wings and set it in place on the hanger. Turn slightly and lower. Make sure all three ceramic wings are securely resting on their hanger ledges. Upright mantles can be lifted off the burner by the wire frame around the fabric of the mantle. Here again, do not touch the fabric, just the metal frame.
3. Every new mantle must be burned off before you relight your gas lamp. After the mantle is in place but before you relight your lamp, hold a lighted match close to, but not touching the mantle. It may take more than one match to burn the coating off an upright mantle. If your gas lamp has a chimney, replace the chimney taking care not to touch the mantle.
4. Relight your gas lamp by holding a match close to, but not touching, the mantle as you turn the slotted head of the valve back to the vertical position. After relighting, replace the glass panel and your gas lamp is as good as new.

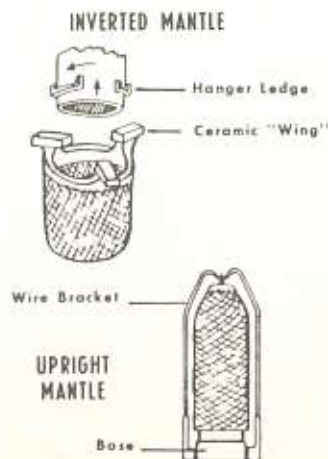

CLEANING YOUR GAS-FIRED OUTDOOR BARBEQUE

1. Turn off your barbeque. Remove the stainless steel cooking grid as soon as it has cooled. Wipe it with a damp cloth or place it in a hot water and detergent solution. Use a damp cloth to wipe off spatters on any other metal surface. Stainless steel cooking grids, due to intense heat, may develop a rust color or stain. To remove, rub with nylon cleaning pads.
2. Clean the Charm-Rok by allowing them to cool completely, then turn each one over so that the dark side is downward. Let the gas burn on high for about 20 minutes. This should burn most of the accumulated grease drippings off the Charm-Rok. The Charm-Rok should be spread evenly, one rock thick, covering the entire grate with some air space between each one.
3. Your Charmglow gas-fired outdoor barbeque is rust-free and weatherproof because it is made of cast aluminum. A cloth dipped in hot water and detergent will remove most cooking stains, as well as any dirt deposited by wind or rain. Most stubborn stains may be removed by using a soft brush dipped in the same mixture. Because of the extreme cooking temperatures and weather elements the aluminum of the body and cover may bleed through the paint and cause white spotting. To remove, brush with wire brush or steel wool to loosen all particles, then spray with Charmglow's heat resistant paint. Wiping off the exterior of the grill with a cloth dampened with cooking oil will remove any white oxidation and inhibit any more from forming. This should be done while the grill is hot. Although your Charmglow gas grill is rustproof because it's made of cast aluminum, cover protection from continued exposure to weather and dust benefits the condition of your grill.
4. It is advisable, for thorough cleaning, to remove the H burner several times throughout the year. Wire brush H burner, clean ports and venturi tube making sure that there are no spider webs or foreign matter to obstruct the gas flow. This will add years to your cooking enjoyment. Also, if you have the model JAK, TNK, AMK, HEJ and SNR, rotate the pit occasionally to keep it free on the post. One word of warning: When the barbeque is hot, the thumb screw is also hot.

ORDER DIRECT FOR CHARMGLOW ACCESSORIES

Rotisseries, shish kebabs, griddles and other accessories are available from Charmglow direct. Just drop a card requesting information on Charmglow accessories to:

CHARMGLOW PRODUCTS

Antioch, Illinois 60002

INSTRUCTIONS FOR INSTALLING THE *Charmglow*® 440181 GREASE CUP HOLDER

(FOR MODELS AMK, JAK, TNK & HEJ-1 BARBEQUES)

1. Make sure the gas is turned off and the barbeque pit is not hot.
2. Temporarily remove thumb screw from slip fitter collar on underside of pit.
3. That portion of the grease cup holder which has the hole is to fit around the slip fitter with hole centered over the thumb screw hole. (Note orientation of holder in illustration.) By replacing and tightening thumb screw, holder is held in proper position.
4. Ring which holds cup may be squeezed together or pulled apart to accommodate different sizes of paper or metal grease cups.

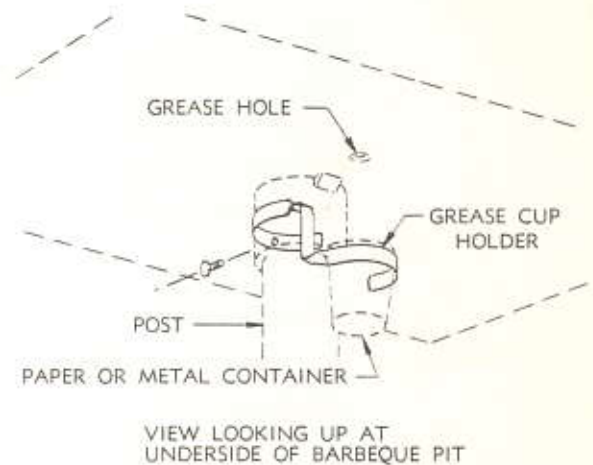

NOTE: If the directions for cooking are followed as specified in Charmglow's Cookbook, or if foods are cooked which are low in fat content, there may be no grease at all to reach the grease cup. If grease does collect in the grease cup, however, make sure fire is out and both pit and grease cup have completely cooled before changing container.

CHARMGLOW PRODUCTS

ANTIOCH, ILLINOIS 60002

2271

PHONE: (312) 395-4221

Instructions For Using "Portable" LP - Gas Tanks Do Not Place LP Tank Under Barbeque



With large "home-sized" LP-gas tanks, as with natural gas, a standard regulator controls the "house pressure" for general gas service.

However, if you plan to use your Charmglow Gas Barbeque with a "portable" LP-Gas tank (for example, a 20-pound tank as shown here), this smaller tank must be equipped with the POUNDS TO 11-INCH W.C. REGULATOR. This is the normal type used for LP service and gives you the same type of pressure standard in the larger "home-sized" LP tanks.

Have your LP dealer fit your small "portable" LP tank with this regulator for correct usage.

IMPORTANT NOTICE

When converting Barbeque's from natural gas to LP gas, it is absolutely necessary to change the orifice, valve, regulator, and special bolt in regulator, to: Orifice LP, Valve LP, Valve Adaptor LP, and Hex bolt for your particular model Charmglow Barbeque.

LP gas can not be used with a Barbeque equipped for natural gas.

NOTICE

Cast iron gas range burners need to be removed occasionally for a thorough washup. Clean the hollow fuel tube with a bottle brush, and use a pipe cleaner to scrape out the small holes. Then wash in hot soap or detergent suds, rinse, wipe off and place in a warm oven to dry completely.

Women have been caring for gas ranges and prolonging the good quality of their gas range burners since they originated.

The same should certainly apply to outdoor gas grill burners—even more so. With the outdoor dirt accumulation, plus the barbeque drippings, this same procedure should be applied to preserve the outdoor gas appliance burner.

(Over Please)

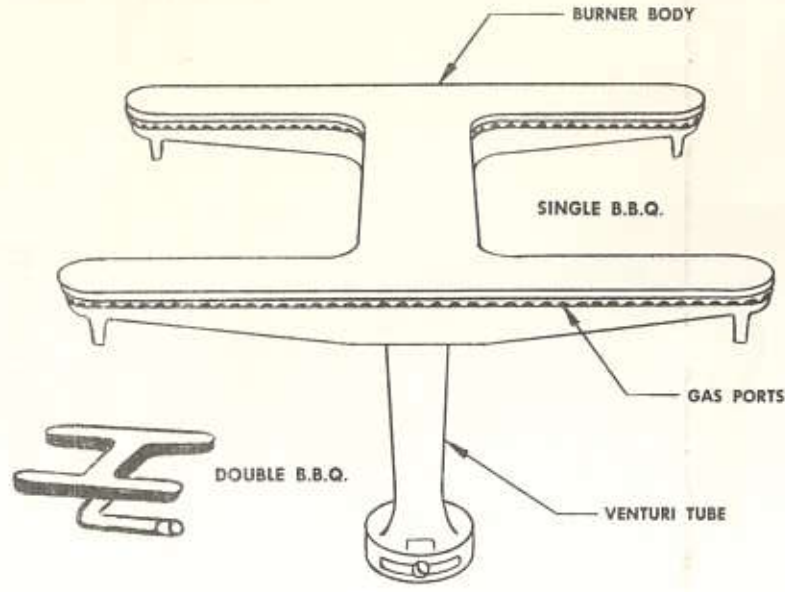

IMPORTANT INFORMATION REGARDING YOUR BURNER

Your Charmglow burner is made of the finest materials available.

However, because of excessive abuse this burner receives from the high heat, rain, snow salts, cooking fats, etc., etc., a certain amount of maintenance is required to keep the burner in the best condition.

At least twice a year remove the burner, brush burner thoroughly to remove all scaling from burner body and ports.

Check venturi tube for spider webs and clean.

This will take only a few minutes of your time but add years to your cooking enjoyment.

Charmglow[®] PRODUCTS

ANTIOCH, ILLINOIS
60002

Division of Beatrice Foods Co.



ACCESSORIES FOR THE BARBEQUE

PRICES EFFECTIVE JANUARY 1, 1974

SUPERSEDES ALL OTHER PRICE LISTS

THE FINE ACCESSORIES SHOWN IN THIS FOLDER ARE MADE ESPECIALLY FOR CHARMGLOW'S CAST ALUMINUM OUTDOOR BARBEQUES. THEY COMPLEMENT THE UNIT AND WILL ADD YEARS OF ENJOYMENT AND ADDED EFFICIENCY TO YOUR ENJOYABLE TASK OF OUTDOOR MEALMAKING.

SHIPPING: Prices are F.O.B. Factory, therefore the customer has full responsibility for filing claims for any damage or loss in transit. Obviously, Charmglow Products, will be as helpful as possible in furnishing required documents and other evidence as required but Charmglow Products, cannot assume responsibility for filing damages or loss claims with carriers, nor for negotiating settlements in such matters. It is understood that when Charmglow Products company trucks deliver to the customer's loading dock, responsibility for damages and shortages will be assumed by Charmglow Products if noted at time of delivery. Advise Charmglow of any shortages or overages within 3 days after receipt of shipment. This policy also applies to all sealed shipments other than Charmglow truck. **It is also understood that the customer will count each unit received and sign for the exact amount delivered as the signature constitutes acceptance of the exact number of units received.**

RETURNING MERCHANDISE: No merchandise or parts may be returned for credit without written permission to do so. Transportation charges must be prepaid on returned equipment. All returns are subject to inspection and evaluation by the factory. No equipment or parts will be accepted for credit if the replacement equipment or parts have not been purchased from Charmglow Products. All merchandise accepted for return will be subject to a 10% handling charge, plus the cost of any missing or damaged parts requiring replacement. No used equipment will be accepted for credit. Any defective parts returned to Charmglow within the warranty period will be repaired or replaced and will be returned to the customer, transportation prepaid. If the item is out of warranty, the cost of repairs and transportation to and from the customer must be paid by the customer.

All shipments of returned merchandise to Charmglow should be shipped prepaid only to Highway 45, Bristol, Wisconsin 53104.

Retail prices are suggested only and may vary in different trading areas.

THE CONTINUOUS IMPROVEMENT OF ITS PRODUCTS IS THE POLICY OF CHARMGLOW PRODUCTS, WHO RESERVE THE RIGHT TO CHANGE SPECIFICATIONS WITHOUT NOTICE.

WHEN YOU BUY *Charmglow*. . . YOU BUY THE FINEST

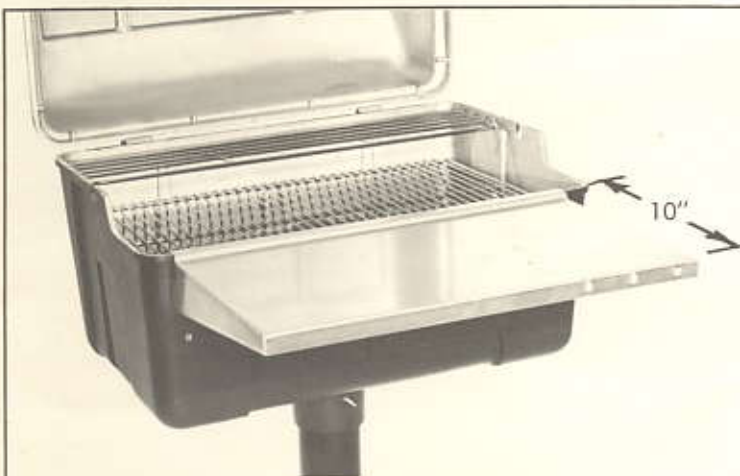

THIS ACCESSORY MAY BE USED FOR
ALL MODELS EXCEPT SNR

SHELF, Anodized aluminum
160270, Shipping Weight 2 lbs. \$6.00

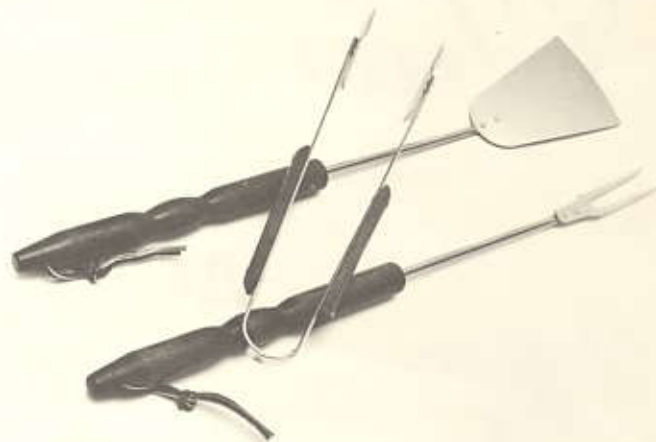

THIS ACCESSORY MAY BE USED FOR
ALL MODELS

UTENSIL SET, stainless steel
160290, Shipping Weight 1½ lbs. \$6.50



THIS ACCESSORY MAY BE USED FOR
ALL MODELS

4 Way SHISHKABOB,* chrome plated steel
160320, Shipping Weight 1½ lbs. \$6.30



ROTISSERIE HEIGHT INCREASER, cast
aluminum* (JAK and TNK models only)

160400, Shipping Weight 7½ lbs. \$26.50



THIS ACCESSORY MAY BE USED FOR
ALL MODELS

WIENER WHEEL,* chrome plated steel
160820, Shipping Weight 1 lb. \$4.30



COVER, vinyl plastic

160300 JAK & TNK, Shipping Weight 1½ lbs.	\$5.50
163300 AMK, Shipping Weight 1¾ lbs.	\$5.50
164300 HEJ-1, Shipping Weight 2½ lbs.	\$7.10
162350 CC-1, Shipping Weight 3 lbs.	\$9.30
167300 SNR, Shipping Weight 2½ lbs.	\$7.10
168300 TPC, Shipping Weight 1¼ lbs.	\$6.20

*Rotisserie Not Included

SEE ORDER BLANK ON BACK

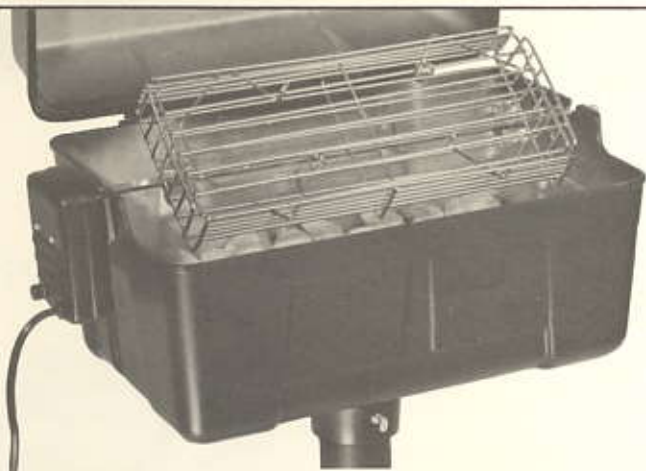

THIS ACCESSORY MAY BE USED FOR ALL MODELS

All Purpose **ROTISSERIE BASKET**,*
chrome plated steel
160310, Shipping Weight 4 lbs. \$9.90

Porcelainized Cast Iron
Cooking Grid for Model
HEJ-1 Barbeque
444063 \$15.50
Shipping Weight 3 lbs.

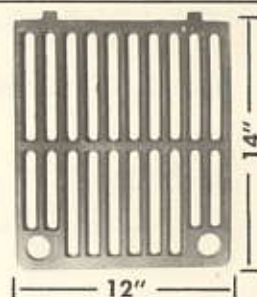

Porcelainized Cast Iron
Cooking Grid for Models
AMK & CC-1
443061 \$18.70
Shipping Weight 8½ lbs.

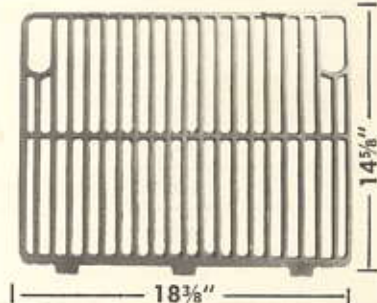

THIS ACCESSORY MAY BE USED FOR ALL MODELS

GRIDDLE, cast aluminum (17 3/8" x 10 7/8") fits all but TPC, 160790, Shipping Weight 5 lbs. \$16.60
TPC GRIDDLE, cast aluminum (12 1/2" x 12")
168970, Shipping Weight 4 lbs. \$12.30

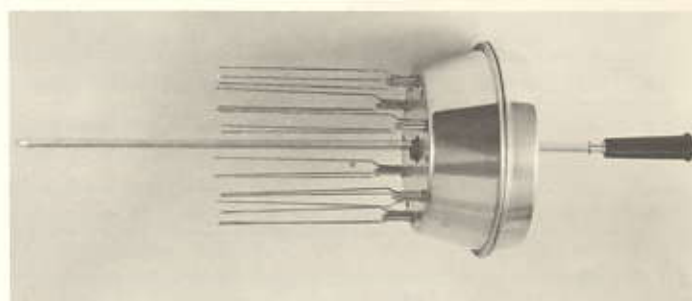

BARBESKEWER 160325 \$20.90



ROTISSERIE SET, electric
162340 CC-1 \$27.00
Shipping Weight 5 lbs.
160330 JAK & TNK \$22.00
163330 AMK \$22.00
164330 HEJ-1 \$22.00
167330 SNR \$22.00
Shipping Weight 4 lbs.

CHARMROK
36 Pieces
448160 \$5.00
Shipping Weight
4½ lbs.



CHARMROK
64 Pieces
440160 \$8.70
Shipping Weight
7½ lbs.



HICKORY CHIPS, set of
12-12 oz. packets
160410 \$9.90
Shipping Weight 11 lbs.



BLACK PAINT
160250
Heat-resistant for
Touch-up use
Price: \$4.50
Shipping Weight 1½ lbs.



*Rotisserie Not Included

SEE ORDER BLANK ON BACK

SEE YOUR LOCAL DEALER OR

ORDER BLANK

MAIL TO: CHARMGLOW PRODUCTS, 908 MAIN ST., ANTIOCH, ILLINOIS 60002

Quantity	Model Number	Description	Unit Price		
A	160270	SHELF, Anodized Aluminum	\$ 6.00		 <p>Nylon Cleaning Pads Charm. Pad 160420 (5 pads), \$1.60 Shipping Weight ½ lb.</p>
B	160290	UTENSIL SET, Stainless Steel	6.50		
C	160310	All Purpose ROTISSERIE BASKET, Chrome Plated Steel	9.90		
D	160320	4-Way SHISHKABOB, Chrome Plated Steel	6.30		
E	160400	ROTISSERIE HEIGHT INCREASER, Cast Aluminum	26.50		
F	160790	GRIDDLE, Cast Aluminum (All but Charmglowette)	16.60		
FT	168790	CHARMGLOWETTE GRIDDLE, Cast Aluminum	12.30		
G	160820	WIENER WHEEL, Chrome Plated Steel	4.30		
H	160300	COVER, Vinyl Plastic, for Models JAK & TNK	5.50		
I	163300	COVER, Vinyl Plastic, for Model AMK	5.50		
J	164300	COVER, Vinyl Plastic, for Model HEJ-1	7.10		
K	167300	COVER, Vinyl Plastic, for Model SNR	7.10		
L	162350	COVER, Vinyl Plastic, for Model CC-1	9.30		
LT	168300	COVER, Vinyl Plastic, for Model TPC	6.20		
M	160330	ROTISSERIE SET, for Models JAK & TNK	22.00		
N	163330	ROTISSERIE SET, Electric, for Model AMK	22.00		
O	164330	ROTISSERIE SET, Electric, for Model HEJ-1	22.00		
P	167330	ROTISSERIE SET, Electric, for Model SNR	22.00		
Q	162340	ROTISSERIE SET, Electric, for Model CC-1	27.00		
R	444063	PORCELANIZED CAST IRON COOKING GRID for Model HEJ-1	15.50		 <p>L.P. Tank Holder for HEJ-1, AMK & CC-1 Shipping Weight 5 lbs. 164500 \$9.90</p>
S	443061	Cast Iron Cooking Grid for models AMK & CC-1	18.70		
T	160325	BARBESKEWER	20.90		
U	440160	CHARMROK (For all but TPC), 64 pieces	8.70		
W	448160	CHARMROK for Charmglowette, 36 pieces	5.00		
X	160410	HICKORY CHIPS, Set of 12 - 12 oz. Packets	9.90		
Y	160250	BLACK PAINT, Heat-Resistant for Touch-up Use	4.50		
Z	160420	Nylon Cleaning Pads	1.60		
AA	164500	HEJ-1 L.P. Tank Holder	9.90		

A NEW PRICE LIST WILL BE SENT WITH EACH ORDER

CASH MONEY ORDER CHECK # _____ TOTAL ENCLOSED \$ _____

Postage, Tax and Insurance are included in retail price. No C.O.D. Orders accepted. Allow 3 weeks for Delivery.

TO:

Name _____

Address _____

City _____

State _____ Zip _____

Form #2573

Do not write in this space
Order # _____

Charmglow



Party Host: Model HEJ-1 Grill Parts
 Gas Grill Parts from Grill Parts Distributors.



**Party Host
 Model HEJ-1**
 Popular Parts:

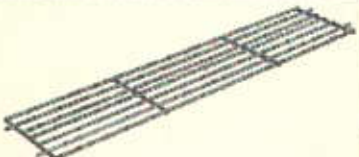
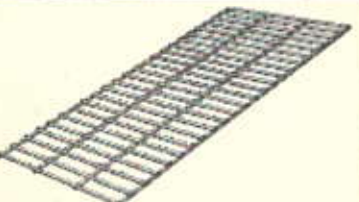

Description	Price	Shopping Cart
Burner Assembly. H-Shaped, Stainless Steel Burner with Single Venturi Tube going down the post. Length of the Venturi Tube is approximately 6 15/16 inches. Comes with burner, gaskets and screws, and venturi tube.	\$32.75 <i>in stock</i>	<input type="button" value="Add to Cart"/>
Burner - Cast Iron. At various times over the years, cast iron replacement burners have been made for older Charmglow models. The quality of these burners has been inconsistent, from poor to fair. We do not stock or sell cast iron burners for Charmglow grills. We recommend and sell the stainless burner listed above.		
Chrome Plated Warming Rack. Size: 5 1/8 by 24 3/4 inches. 	\$7.50 <i>in stock</i>	<input type="button" value="Add to Cart"/>
Chrome Plated Cooking Grid. 2 required. Size: 11 3/4 by 14 3/8 inches. Need 2 cook grids per grill. Select quantity 2 for each grill you have.	\$8.95 each. <i>in stock</i>	Quantity: <input type="text" value="2"/> <input type="button" value="Add to Cart"/>
Porcelain Coated Wire Cooking Grid. 2 required. Size: 11 3/4 by 14 3/8 inches. Need 2 cook grids per grill. Select quantity 2 for each grill you have.	\$13.95 each. <i>in stock</i>	Quantity: <input type="text" value="2"/> <input type="button" value="Add to Cart"/>
Steel Rod Rock Grate. Size: 12 by 22 3/4 inches. 	\$12.95 <i>in stock</i>	<input type="button" value="Add to Cart"/>
	\$14.95	<input type="button" value="Add to Cart"/>

<p>Our ceramic briquettes, popular for over fifteen years, are approximately two inches square, flat on the bottom and forming a four-sided pyramid shape on top to absorb and burn up the grease. Our bag of 60 briquettes cover the rock grate of any Charmglow grill. We have just one shipping charge per order so you can add a bag for no additional shipping charge.</p>	 <p style="text-align: center;">60 Pieces</p>	<p>For 60 briquettes <i>in stock</i></p>	
<p>Single Valve - Propane: Single Valve, One Control knob for Propane. One venturi tube from the burner to the valve in the post. The Charmglow valve for propane is mounted on a aluminum mounting block and this block has a nut or screw that holds it in position on the post. We suggest the customer get both the valve (18.95) and the mounting block (9.50). The valve does not come with the control knob, which can be ordered below.</p>	<p>\$18.95 <i>in stock</i></p>	<p>Add to Cart</p>	
<p>Mounting Block: This is the cast aluminum block that goes below the propane valve to hold the valve in place on the post. Comes with brass mounting screw. Use pipe dope or Teflon tape to seal it when screwing mounting adapter onto valve.</p>		<p>\$9.50 <i>in stock</i></p>	<p>Add to Cart</p>
<p>Dual Valve: Charmglow produced a limited number of grills with "dual" valve and single control knob. The burner had two venturi tubes that went down the post and with the on knob you could turn on one side or the whole burner. Some model numbers were HEJ-1T or 3200. Unfortunately, we are sold out of this dual valve with the single knob and have no source for more. Cannot supply.</p>	<p>No longer available.</p>		
<p>Single Valve - Natural Gas: Single Valve, One Control knob Natural Gas. One venturi tube from the burner to the valve in the post. The Charmglow valve for Natural Gas is mounted on a natural gas regulator and this NG regulator has a nut or screw that holds it in position on the post. We suggest the customer get both the valve (18.95) and the natural gas regulator. The valve does not come with the control knob, which can be ordered below.</p>	<p>\$18.95 <i>in stock</i></p>	<p>Add to Cart</p>	
<p>Natural Gas Regulator: On natural gas models of the HEJ-1, there is a natural gas regulator that mounts below the NG valve in the post. The valve screws into the regulator. Use pipe dope or Teflon tape to connect and check for leaks. The regulator comes with a brass screw to hold it in place on the post.</p>		<p>\$18.95 <i>in stock</i></p>	<p>Add to Cart</p>
<p>Handles: See the section below.</p>			
<p>Posts: See the section below.</p>			
<p>Post Collar Kit: See the section below.</p>			
<p>Single Control Knob for Model HEJ-1.</p>	<p>\$2.95</p>	<p>Add to Cart</p>	

in stock

Owner's Manuals, Instruction Books, and Parts List. The original Charmglow company went out of business approximately 25 years ago. We have no owner's manuals, instruction books, or parts list to provide for these grills. Sorry.



Other Parts: Sorry, we have no top or bottom lid castings for the Model HEJ-1. We have no cart parts, no legs, wheels, wheel axles, wheel hub caps, or control panels for this model.

Rotisseries, Covers, and Accessories. Sorry, we don't stock, sell or have any rotisserie kits, rotisserie motors, rotisserie parts, covers, shelves or any other accessories for old Charmglow models. And, unfortunately, we have no referral information for these items either.

[Review My Cart / Check Out](#)

For Party Host: Model HEJ-1, we also stock:

Handle Kits: Charmglow used two different handle kits in different model years. Please make a choice from the two styles below. The front handle kit goes across the front of the top lid of the grill. The side handle kit goes in the side of the top casting. Details below.

	<p>Front Wooden Handle Kit. Two holes in front casting of grill to mount wood handle across front. Includes Hardware.</p>	<p>\$5.85 <i>in stock</i></p>	<p>Add to Cart</p>
	<p>Side Wooden Handle Kit. Side wood handle mounted on side of top casting through single hole.</p>	<p>\$4.50 <i>in stock</i></p>	<p>Add to Cart</p>
<p>Adjustable Side Wooden Handle Kit</p>	<p>Adjustable Side Wooden Handle Kit. Charmglow grills used to have a side wooden handle that went in the lid of the grill and had an adjustable arm that could prop the lid open at different heights. These adjustable handle is discontinued and no longer available. You can substitute the Side Wooden Handle Kit listed above to open and close the lid. But opening adjustment is not available.</p>		

<p>24 inch Pedestal Mount Post Front Back</p> 	<p>24 inch post. Can be used for either the old Charmglow rollaround cart or the round pedestal base. \$21.95 <i>in stock</i></p> <p>Add to Cart</p>
	<p>9 1/2 inch post used on some cart models. (not shown) \$17.95 <i>in stock</i></p> <p>Add to Cart</p>
	<p>48 inch in ground post. \$28.00 <i>in stock</i></p> <p>Add to Cart</p>



Post Collar Kit (not shown). On some Charmglow models, there was a two-piece post collar (like a dog collar) that secured the 3 inch post to the bottom of the grill casting. This has not been available since 1990. We have none in stock and no substitute. Sorry.

48 inch
in ground posts.
Front Back



Round aluminum pedestal base for 24 inch post. **\$37.50 in stock**

[Review My Cart / Check Out](#)

**Grill Parts Distributors, 6150 49th Street North,
St. Petersburg, Florida 33709**

We only sell the popular parts for [16 brands of gas grills](#). All the parts we sell are shown or listed on our website. We offer shopping cart ordering - either by model number, by part number, or by a descriptive, illustrative list of parts. For grill brands we don't sell, we provide contact information. [Click Here](#).

How To Order: All orders are placed through our website: gasgrills.com. Please use our online shopping carts for efficient order processing. We do not accept orders by phone, fax, or mail. We do not offer phone or fax service.

How To Pay: Orders can be charged to Visa, MasterCard, or Discover. Sorry, we do not accept American Express, money orders, or checks. We do not provide COD shipments, nor do we accept orders by mail. If you mail an order, the mail will be returned to you.

How We Ship: We ship 95 percent of our orders from in-stock inventory within 5 business days of receipt of order. We ship from St. Petersburg, Florida. We ship to the 48 United States via United Parcel Service (UPS) ground service only. [Click here](#) for our low UPS freight rates from \$4.95 to \$6.95 depending on state of destination. We ship to Alaska, Hawaii, Puerto Rico, Guam, U.S. possessions, and APO and FPO addresses via U.S. Priority Mail. We do not ship to any other destinations or addresses. We do not offer air shipments.

[Delivery Times / Rates / Policies](#)

[Overseas Shipping](#)

[Returns Policy](#)

[Missing/Damaged Parts in Our Shipments](#)

[Privacy Policy](#)

To Send Order Inquiry, Click Here: Orders@gasgrills.com [Click Here for Secure Form](#)

[Back to the Charmglow Page](#)
[Back to the Home Page](#)

Copyright © 1997- 2003, Grill Parts Distributors. All right reserved. Propane and natural gas are explosive and dangerous. We urge all consumers to be careful when using and repairing their gas grill. Do not use unsafe grills. Grills should be used according to manufacturer's specifications. The owner's manual often provides a good troubleshooting guide. If you have concerns about the repair of your gas grill, we urge you to contact a local gas appliance service company or the local gas company in your area. Also, grill manufacturers have customer service help lines to assist consumers.